

L2122

Ink Elegant Pavilion



L2122 Instruction manual

NOTICE OF ASSEMBLE

Tips for assembling

1. Because this product contains small parts, children need to use this product with an adult to avoid accidental ingestion and cause suffocation hazard.
There are sharp objects in the product, be careful not to pierce people to avoid injury.
2. After all the materials are used in the required amount in the operation steps, put the remaining materials back into the original bag until the installation is completed.
(Avoid losing materials during the installation process)
3. The unit of dimension marked in the step diagram is "cm".
4. Tips for making template paper: Put the template on the back of the material, fix it with some small double-sided tape, and then cut out the material to prevent the cloth or template from moving in the cutting process, or causing errors in the cut material. Or lead to insufficient materials.
5. According to the "Parts Rule Example" at the bottom of this page, refer to the parts on the part number drawing, find the actual product and compare it with the bill of materials, and then install it after confirming that it is correct. (Wooden parts only)
6. It is not advisable to apply too much glue, so as not to wait for a longer time to dry, and overflow will affect the effect of the finished product.
7. There are unavoidable small deviations in the color of wood, fabric, and beads of different batches, without notice, thanks for understanding.

Tips for Assembling Wood



Find the corresponding block number, use a knife in the connection point gently press, you can take out the wood.



Use a knife to smooth out the burr.

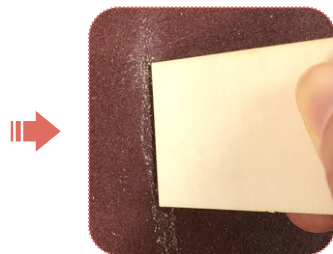

Or use sandpaper to smooth out the burr

Testing on LED function

Be sure to test the LED lights before making the lighting, note that the LED white wire to the negative, gray wire to the positive reference to the following figure operation test.

1

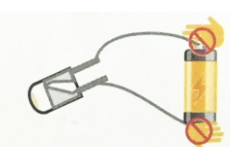

DO NOT contact the LED wire end direct to the battery cell.

2

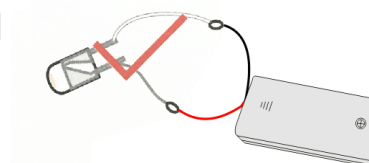

Use the provide battery holder. Make sue the correct polarity.

How to assemble the battery holder



1. Material and tools needed:
- Battery holder, LED bulb, tape, screw driver and 2 pieces AAA size battery(not provided)



2. Use screw driver and take the lid off from the battery holder.

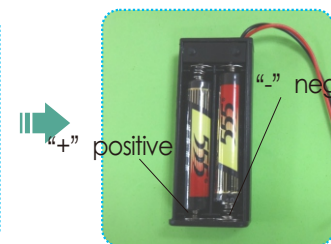

3. Insert the battery take notes on the polarity.

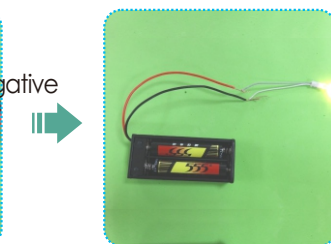

4. Connect the red wire to grey wire. Connect the black wire to white wire.

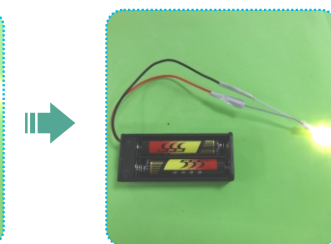

5. Wrap the exposed wire with the tapes.

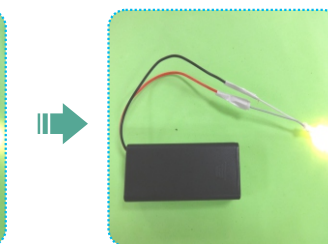

6. Place the box lid and fastness with screw driver.

Examples of parts rule:

A01: The parts are directly in the box; B01: The parts are in the B bag; C01: The parts are in the C bag, and so on (Note: The printing paper is displayed in the step A19-01: The printing paper is placed directly in the box, The part number is A19-01. In the step, the template paper A20-P01 is displayed, A20 is the template paper, P01 is the cutting template used for the corresponding material, P01-01, P01-02 are the part numbers for the parts, and the printing paper and template paper are directly placed in the packaging box.)

Catalogue

Name	Related Materials Bag	
Printing Paper	A19、A20 in Bag A (all of Printing paper and Template are in A19、A20, total 6 sheets of A3 paper+1 sheet of A4 paper)	
Desk & Low Stool	B bag + N bag + P bag + Printing Paper	Page 3
Book Shelf	B bag + M bag + N bag + Printing Paper	Page 3
Screen	B bag + Printing Paper	Page 3-4
Second Bed	B bag + P bag + Template paper	Page 4
Light of Study Room	C bag + R bag + Printing Paper	Page 5
Tea table	C bag + M bag + N bag + P bag+ Template paper	Page 5
Guzheng	C bag + Printing Paper	Page 5-6
Stand	C bag + M bag + P bag + Template paper	Page 6
Table&Chair	D bag + M bag + N bag + P bag + Template paper	Page 6-7
Living Room-Component	D bag + M bag + Q bag + P bag + Template paper	Page 7
Kitchen	A bag + Printing Paper	Page 8
Cosmetics	D bag + M bag + N bag + P bag + R bag+ Template paper	Page 8-9
Bathtub&Toilet	A bag + E bag + P bag + Printing Paper + Template paper	Page 9
Cabinet & Low Table	E bag + M bag + N bag+ P bag + Q bag + Template paper	Page 9-10
Artistic Flower Arrangement	E bag + N bag + Q bag	Page 10
Master Bed	A bag + E bag + P bag + Template paper	Page 10-11
Pillow & Calligraphy	E bag + P bag + Printing Paper + Template paper	Page 11-12
Light	F bag + R bag + Printing Paper	Page 12
Bathtub & Checkerboard	A bag + F bag + G bag + M bag + P bag + Printing Paper	Page 12
rockery&Plant	F bag + P bag + Q bag +R bag + Printing Paper	Page 12-13
Assembly The Base	A bag + F bag + G bag + M bag + N bag + P bag + R bag + Printing Paper + Template paper	Page 13-18
Assembly On The First Floor	A bag + F bag + G bag + H bag +P bag + Printing Paper + Template paper	Page 18-20
Second Floor-Kitchen	A bag + H bag + J bag + R bag + Printing Paper + Template paper	Page 20-22
Kitchen	A bag + J bag +K bag + P bag + Q bag + R bag + Printing Paper + Template paper	Page 22-25
Second Floor-Kitchen	A bag + H bag + J bag +K bag + M bag + N bag + P bag + R bag + Printing Paper + Template paper	Page 25-27
Roof Of Study Room & Assembly The Pavilion	A bag + J bag + K bag + Q bag + Printing Paper + Template paper	Page 27-30
Courtyard Layout	L bag + M bag + N bag + P bag + Q bag + Printing Paper	Page 30-31
Fence&Doorway	Abag + L bag + M bag + N bag + Q bag	Page 31-32
Installation Of Battery Box	R bag+ Printing Paper	Page 33

Thumbnail of material list (reference only)



Thumbnail of printing paper & template paper (reference only)



Symbol description used

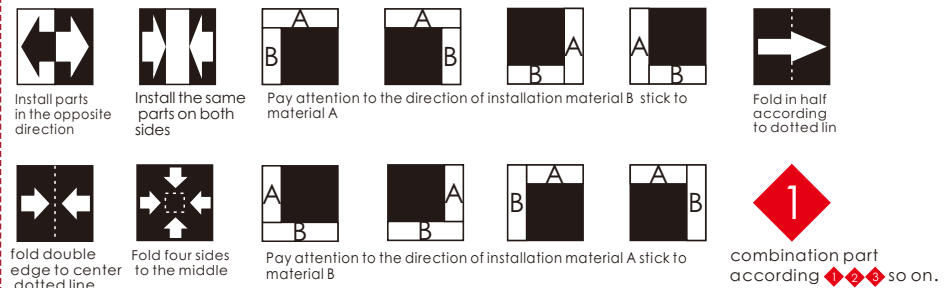

About the use of glue

Method for using glue:

1. After applying the glue, let it dry for a few seconds before pasting.
2. Fix it slightly with your hands, and finally put it aside to dry;

Tips:

When pasting the plane printing paper, a piece of waste bank card or telephone card can be used to wipe evenly after the glue is smeared on the wood board, and then the printing paper is pasted to squeeze out the air inside.

Types of glue:

White latex: Used for adhering soft materials, such as wood and paper.







Alcoholic Glue: Used for adhering hard materials such as cloth, plastic, beads, wire, dust cover, etc.

*Tips for cutting and making template paper: Put the whole template on the back of the material, fix it with some small double-sided tape, and then cut out the material to prevent the fabric or template from moving during the cutting process, or cause errors in the cut material. Or lead to insufficient material.

Desk & Low Stool					
					
					
					
Book Shelf					
					
					
					
Screen					
			<p>Overlap and glue A19-04-01 and A19-04-02 together</p>	<p>Make the rest in the same way</p>	

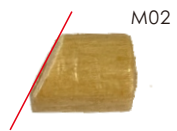
*Tips for cutting and making template paper: Put the whole template on the back of the material, fix it with some small double-sided tape, and then cut out the material to prevent the fabric or template from moving during the cutting process, or cause errors in the cut material. Or lead to insufficient material.

<p>4</p> <p>Screen 1</p>	<p>Second Bed</p>			<p>1</p>	<p>2</p>	<p>3</p>
<p>5</p> <p>Screen 2</p> <p>In the same way, make another group</p>	<p>Before making, please cut out P01, P02, P04, P05, P07, P08 according to A20-P01, A20-P02, A20-P04, A20-P05, A20-P07 and A20-P08 template paper.</p>			<p>4</p>	<p>5</p>	<p>6</p> <p>mattress (front)</p>
<p>7</p> <p>P02-01</p> <p>Fold both sides by 0.3CM</p>	<p>8</p> <p>Fold it in half and glue the sides together</p>	<p>9</p>	<p>10</p> <p>P17</p> <p>Stuff with some P17 cotton.</p>	<p>11</p> <p>pillow</p> <p>Sew the opening and trim off the excess</p>	<p>12</p> <p>P05-01</p> <p>Fold both sides inward by 0.5CM (front)</p>	
<p>13</p> <p>1.1CM</p> <p>Fold about 1.1CM from the bottom</p>	<p>14</p> <p>Fold again</p>	<p>15</p> <p>Fold the other end inward</p>	<p>16</p> <p>quilt</p>	<p>17</p> <p>B18</p> <p>P07-02</p>	<p>18</p> <p>cut in the middle</p>	
<p>19</p>	<p>20</p> <p>B20</p> <p>P07-01</p>	<p>21</p> <p>(front)</p>	<p>22</p> <p>B16</p> <p>B15</p>	<p>23</p> <p>B17</p> <p>B17</p>	<p>24</p> <p>B16</p> <p>(Bottom)</p>	
<p>25</p> <p>B20</p> <p>B19</p> <p>2</p>	<p>26</p> <p>B18</p>	<p>27</p> <p>床垫</p>	<p>28</p> <p>P07-03</p> <p>(left)</p>	<p>(right)</p>	<p>29</p> <p>pillow</p> <p>quilt</p> <p>Second Bed</p>	

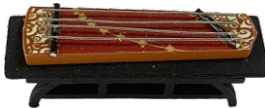
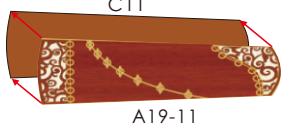
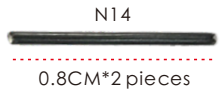
<p>Light of Study Room</p>  <p>C01 C02 R01 A19-10</p>	<p>1</p>  <p>A19-10</p>	<p>2</p>  <p>R01</p>	<p>3</p>  <p>C02</p>	<p>4</p>  <p>C01</p>	<p>5</p>  <p>Study Room Light</p>
<p>Tea table</p>  <p>C03 C04 C04 C05 C05 C06 C07 C07 C07 C07 C08 C08 C08 C08 C08 C08 C08 C08 M04 M04 M04 M04</p>	<p>1</p>  <p>C04 C03(back)</p>	<p>2</p>  <p>C05 C05</p>	<p>3</p>  <p>C04 C04</p>	<p>4</p> 	
<p>Before making, please cut out P04 according to A20-P04 template paper.</p>  <p>P04-03 M01 M02 N02 (some) N08 N12 N12 N13 R04</p>	<p>5</p>  <p>M02</p> <p>Use R04 sandpaper to rub M02 to a bevel</p>	<p>6</p>  <p>M01 M02</p>	<p>7</p>  <p>N08</p>	<p>8</p>  <p>N13 2.5CM</p> <p>Cut N13 out to 2.5 CM</p>	<p>9</p>  <p>Bend as shown</p>
<p>10</p>  <p>0.9CM 1.1CM</p>	<p>11</p>  <p>Teapot</p>	<p>12</p>  <p>N02 (some) N12</p>	<p>13</p>  <p>Fruit</p> <p>In the same way, make 2, One of them will be used later</p>	<p>14</p>  <p>P04-03 towel</p> <p>Fold in half</p>	<p>15</p>  <p>C06</p>
<p>16</p>  <p>Teapot M04 M04</p>	<p>17</p>  <p>Tea table fruit dish M04 towel M04 M04</p>	<p>18</p>  <p>C08 C08 C07</p>	<p>19</p>  <p>C08 C08</p>	<p>20</p>  <p>C07</p>	<p>21</p>  <p>Round Stool</p> <p>Make 2 pieces in the same way</p>
<p>Guzheng</p>  <p>C09 C10 C10 C11 N14 N15</p>	<p>1</p>  <p>C11 A19-11</p>	<p>2</p> 	<p>3</p>  <p>N14 0.8CM*2 pieces</p>	<p>4</p>  <p>N14 N14</p>	

<p>5</p> <p>N15 3CM*4 pieces</p>	<p>6</p> <p>N15</p>	<p>7</p> <p>C10 C10 C09</p>	<p>8</p>	<p>9</p> <p>Guzheng</p>				
<p>Stand</p> <p>C12 C12 C13 C13 C13 C13 C14 C14 C14 C14 C15 C16 C16 C17 C18 C19 C20 M13 M13</p> <p>Before making, please cut out P18 according to A20-P18 template paper.</p> <p>P18-01 P18-01</p>	<p>1</p> <p>C13 C14</p>	<p>2</p> <p>C14</p>	<p>3</p> <p>C13</p>	<p>4</p> <p>PotStand C12 C12</p> <p>Make 2 pieces in the same way</p>	<p>5</p> <p>P18-01 Roll up P18-01</p>	<p>6</p> <p>P18-01</p>	<p>7</p> <p>Potted Plants M13 M13</p> <p>Make 2 pieces in the same way</p>	
<p>9</p> <p>C16 C15</p>	<p>10</p> <p>C16</p>	<p>11</p> <p>C17</p>	<p>12</p> <p>C18 C19</p>	<p>13</p> <p>C20</p>	<p>14</p> <p>Stand</p>			
<p>Table&Chair</p> <p>Before making, please cut out P01 according to A20-P01 template paper.</p> <p>D01 D02 D02 D03 D03 D04 D04 D04 D04 D05 D05 D05 D05 D06 D06 D06 D06 D06 D06 D06 D06 D07 D07 D07 D07 D07 D07 D07 D07 D08 D08 D08 D08 D08 D08 D08 D08 M13 M16 M16 M18 M20 N01 (some) N07 P17 N14 P01-03 P01-03 A19-12</p>	<p>1</p> <p>D02 D01(back)</p>	<p>2</p> <p>D03 D03</p>	<p>3</p> <p>D02</p>	<p>4</p>	<p>5</p> <p>M13 A19-12 (underside)</p>	<p>6</p> <p>M13 A19-12 (top)</p>	<p>7</p> <p>M18</p>	<p>8</p> <p>M20</p>

<p>9</p> <p>N14 1.5CM</p>	<p>10</p> <p>Bend in half</p>	<p>11</p> <p>N14 0.6CM 0.9CM Trim to size above</p>	<p>12</p> <p>N14 Teapot</p>	<p>13</p> <p>N01 (some) Fruit N07</p>	<p>14</p> <p>Teapot Fruit</p>
<p>15</p> <p>Table M16</p>	<p>16</p> <p>D05 D04</p>	<p>17</p> <p>D06</p>	<p>18</p> <p>D07 D08</p>	<p>19</p> <p>D07</p>	<p>20</p> <p>D07</p>
<p>21</p> <p>3 4</p>	<p>22</p> <p>High Chair</p> <p>Make 4 pieces in the same way</p>	<p>23</p> <p>P01-03</p> <p>Fold both sides of the long side by 0.3CM</p>	<p>24</p> <p>Fold it in half and glue the sides together</p>	<p>25</p> <p>P17</p> <p>Stuff with some P17 cotton.</p>	<p>26</p> <p>Sew the opening and trim off the excess</p>
<p>27</p> <p>pillow pillow</p> <p>Make 2 pieces in the same way</p>	<p>Living Room Component</p> <p>D09 D10 D11 D12 D13</p>		<p>1</p> <p>D11 D09</p>	<p>2</p> <p>D10</p>	<p>3</p> <p>D10</p>
<p>28</p> <p>High Chair+Pillow</p>	<p>M05 Q06 A19-13</p> <p>Before making, please cut out P08 according to A20-P08 template paper.</p> <p>A19-14 P08-03</p>	<p>4</p> <p>D09</p>	<p>5</p> <p>Q06 M05</p>	<p>6</p> <p>Stand</p>	<p>7</p> <p>A19-14 D12</p>
<p>8</p> <p>Mural</p>	<p>9</p> <p>A19-13 P08-03</p>	<p>10</p>	<p>11</p> <p>A19-13 D13</p> <p>Beam Plaque</p> <p>Paste Centered</p>		

Kitchen

Before making, please cut out A15-3, A15-4, A15-5, A15-10, A15-11, A15-30, A15-31, A16-2 in A15, A16 (Please refer to page 1 for production techniques)

1 A15-30
A15-3
The narrow side of A15-3 is pasted with A15-30, note that the side with the engraving number faces outwards

2 A15-31

3 A19-15
A19-17

4 A19-16

5 A19-18

6 A19-20
Cut one of the reference lines, and coincide to another line

7

8 Pot
Make 2 pieces in the same way

9 Pot Pot

10 A19-21
A15-4

11

12 A15-5

13 pot Lid
Make 2 pieces in the same way

14 pot Lid pot Lid
Stove

15 A19-19
A16-2

16

17 Stove Wall

18 A15-11
A15-10

19 A15-11

20 Wooden Stool

Cosmetics

Before making, please cut out P09 according to A20-P09 template paper.

1 D14
D17

2 D15
D16

3 D15

4

5

6 R01

7 M12

8 M17
N05

M03 M12
M17 N03 N05
R01
P09-01
D19 D19
D20 D20
D20 D20

<p>9</p>	<p>10</p> <p>Bronze Mirror</p>	<p>11</p> <p>N03 Cosmetic</p>	<p>Bathub&Toilet</p> <p>Please pull out A15-7, A16-3, A16-4, A16-5, A16-6 in A15 and A16 before making</p> <p>Cut out template paper P06 according to A20-P06.</p>		<p>1</p>
<p>12</p> <p>Bronze Mirror</p>	<p>13</p>	<p>14</p>			
<p>15</p>	<p>16</p> <p>Red Stool</p> <p>Make 2 pieces in the same way</p>		<p>3</p>	<p>4</p>	<p>5</p>
<p>6</p> <p>A19-22</p> <p>Pay attention to the direction of A19-22</p>	<p>7</p>	<p>8</p> <p>Fold both sides inward by 0.5CM</p>	<p>9</p>	<p>10</p> <p>towel</p> <p>(front)</p>	
<p>11</p> <p>towel</p> <p>Bathtub</p> <p>P17</p> <p>Add appropriate amount of P17</p>	<p>12</p> <p>E02</p>	<p>13</p>	<p>14</p> <p>E01</p>	<p>15</p> <p>E03 toilet</p> <p>E03</p>	
<p>Cabinet& Low Table</p> <p>E05, E09, E06, E06, E07, E10, E08, E11, E11, P19-01</p> <p>M16, M16, M20, N17, Q01, Q01</p> <p>Before making, please cut out P19 according to A20-P19 template paper.</p>	<p>1</p> <p>1CM</p> <p>E06, E07</p>	<p>2</p> <p>E06</p>	<p>3</p> <p>E08</p>		

<p>4</p> <p>E05</p>	<p>5</p> <p>E09</p>	<p>6</p> <p>M20</p>	<p style="writing-mode: vertical-rl; transform: rotate(180deg);">Artistic Flower Arrangement</p>		<p>1</p> <p>E12 E13</p>	<p>2</p> <p>E12</p>
<p>7</p> <p>P19-01</p> <p>Roll up P19-01</p>	<p>8</p> <p>P19-01</p>	<p>9</p> <p>Q01</p> <p>0.8CM</p> <p>Trim Q01 to above length</p>			<p>3</p> <p>Pot Stand E14 N04</p>	<p>4</p> <p>N16 3.5CM 2.5CM 2CM Cut to the above length</p>
<p>10</p> <p>Trim out 3</p>	<p>11</p> <p>P19-01</p>	<p>12</p> <p>Q01</p>	<p>6</p> <p>N16 (3.5CM) Q13 (8.5CM) Bundle N16 with Q13</p>	<p>7</p> <p>Q13 (8.5CM) Q13 (5CM) Q13 (5.5CM)</p>		
<p>13</p> <p>Bedside Table E10</p>	<p>14</p> <p>E10 E11</p>	<p>15</p> <p>E11</p>	<p>8</p> <p>Q13 (8.5CM) N04</p>	<p>10</p> <p>Q13 (5.5CM) Make the shape first</p>		
<p>16</p> <p>M16</p>	<p>17</p> <p>M16 M16</p>	<p>18</p> <p>Fruit (previously made) Low Table</p>	<p>11</p> <p>Q13 (5.5CM) N04</p>	<p>13</p> <p>Artistic Flower Arrangement Pot Stand</p>		
<p style="writing-mode: vertical-rl; transform: rotate(180deg);">Master Bed</p> <p>E15 E16 A15-29</p>	<p>Please pull out A15-29 in A15 before making</p> <p>Before making, please cut out P01, P04, P07, P12 according to A20-P01, A20-P04, A20-P07, A20-P12 template paper.</p> <p>E15 E17 P01-02 P04-02 P07-04 P12-01 P12-02 P13 P04-05 P07-05 P15 P16</p>		<p>1</p> <p>P04-02 E15</p>	<p>2</p> <p>P01-02 E15 (wood color surface)</p>		

<p>3</p>	<p>4</p>	<p>5</p> <p>Mattress (front)</p>	<p>6</p> <p>Mattress A15-29</p>	<p>7</p> <p>P12-01 (dark side) P04-05 Put P04-05 close to the upper left / upper right corners of P12-01</p>	<p>8</p> <p>Wrap the three sides of P12-01 inside</p>
<p>9</p> <p>P12-02 Cover P04-05 with P12-02</p>	<p>10</p> <p>P16 7.5CM</p>	<p>11</p> <p>P16 Flip to the front and paste P16</p>	<p>12</p> <p>P13 7.5CM</p>	<p>13</p> <p>P13 (front)</p>	<p>14</p> <p>(back)</p>
<p>15</p> <p>Mattress (front)</p>	<p>16</p> <p>(back)</p>	<p>17</p> <p>E16 P07-04</p>	<p>18</p> <p>(back)</p>	<p>19</p> <p>(front)</p>	<p>20</p> <p>E17 P07-05</p>
<p>21</p> <p>(top)</p>	<p>22</p> <p>(inside)</p>	<p>23</p> <p>(top) P15 Surround E17 with P15</p>	<p>24</p> <p>E16</p>	<p>25</p> <p>Master Bed</p>	
<p>Pillow & Calligraphy</p> <p>Before making, please cut out P03 according to A20-P03 template paper.</p>	<p>1</p> <p>P03-01 Fold both sides of the long side by 0.3CM</p>	<p>2</p> <p>Fold it in half and glue the sides together</p>	<p>3</p> <p>P17 Stuff with some P17 cotton.</p>	<p>4</p> <p>Sew the opening and trim off the excess</p>	
	<p>5</p>	<p>6</p> <p>P14 Circle the pillow with P14</p>	<p>7</p> <p>Make 2 pieces in the same way</p>	<p>8</p> <p>P13 4CM</p>	<p>9</p> <p>Fold it in half and glue the sides together</p>

<p>10</p>  <p>P17</p> <p>Stuff with small cotton.</p>	<p>11</p>  <p>1.7CM</p> <p>Sew the opening and trim off the excess</p>	<p>12</p>  <p>E18</p> <p>A19-23</p>	<p>13</p> <p>Calligraphy</p> 		
<p>Light</p>  <p>F01 F01 F03 F03</p> <p>F02 F02 F02 F02</p> <p>F04 F04 F05 R01</p> <p>A19-24</p>	<p>1</p>  <p>F01 F02</p>	<p>2</p>  <p>F03</p>	<p>3</p>  <p>F02</p>	<p>4</p> <p>Hollow Lampshade</p>  <p>Make 2 pieces in the same way</p>	
<p>Bathtub & Checkerboard</p>  <p>F06 F07 F08 M19 M19 M19 M19 M19 M19</p> <p>A15-9 G01-2 A19-25 A19-26 P04-04</p> <p>Before making, please cut out P04 according to A20-P04 template paper</p> <p>Please pull out A15-9, G01-2 in A15 and G01 before making</p>	<p>1</p>  <p>G01-2 F06</p>	<p>2</p>  <p>A19-25</p>	<p>3</p> <p>Bathtub</p>  <p>P04-04</p>	<p>4</p>  <p>A19-26 A15-9</p>	
<p>rockery & Plant</p>  <p>F10 M05 M08 P17 Q02 Q02 Q09 Q09 Q09 Q11 Q15 A19-27 R01</p>	<p>5</p>  <p>M19</p>	<p>6</p>  <p>F08 F07</p>	<p>7</p> 	<p>8</p> <p>Checkerboard</p> 	
<p>1</p>  <p>A19-27 F10</p>	<p>2</p> 	<p>3</p>  <p>M08</p>			

<p>4</p> <p>R01</p>	<p>5</p> <p>A19-27(Bottom)</p> <p>Note that the light wire goes through the A19-27 round hole</p>	<p>6</p> <p>Add appropriate amount of P17 as photo</p>	<p>7</p> <p>Q15</p> <p>Add appropriate amount of Q15</p>	<p>8</p> <p>Q02 Q02 Q02</p> <p>Trim out 3 pieces from the head of Q02. The rest are reserved for later step</p>	<p>9</p> <p>Q11</p> <p>Cut out the small branch at the bottom of Q11, as shown in the picture</p>
<p>10</p> <p>Cut out two branches</p>	<p>11</p> <p>Q02 Q02 Q02 Q11</p> <p>Add appropriate amount of Q02, Q11 as photo</p>	<p>12</p> <p>Q09 Q09 Q09</p> <p>Trim out 3 pieces of Q09</p>	<p>13</p> <p>Plant M05</p>		

Assembly The Base

<p>1</p> <p>A01 (The side without the groove)</p> <p>A19-57</p> <p>Pay attention to paste in the direction of the pupil</p>	<p>2</p>	<p>3</p> <p>Cut out template paper P10 according to A20-P10.</p> <p>P10-01</p> <p>Pay attention to opening the round hole so that the light wire can be passed through later</p>
---	----------	--

<p>4</p> <p>G01-1 G01-1 G01-1 G01-1</p> <p>Please pull out G01-1 in G01 before making</p> <p>Flip to the back and glue G01-1 flush with the corner</p>	<p>5</p> <p>R01</p> <p>A19-57</p> <p>Install R01 according to A19-57 and the hole position in the picture, and pass the lamp wire through the hole at the end</p>	<p>6</p> <p>Back view, pay attention to hide the lamp wire in the groove</p>
--	---	--

*Tips for cutting and making template paper: Put the whole template on the back of the material, fix it with some small double-sided tape, and then cut out the material to prevent the fabric or template from moving during the cutting process, or cause errors in the cut material. Or lead to insufficient material.

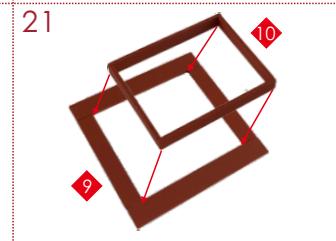
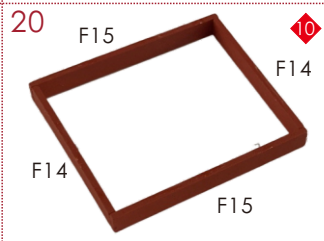
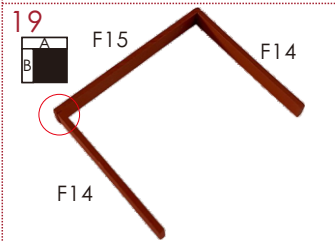
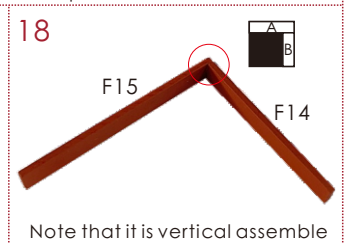
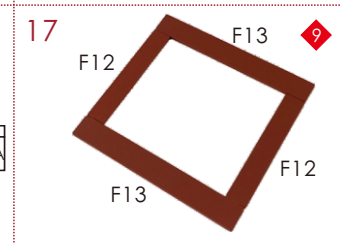
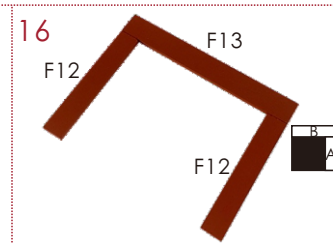
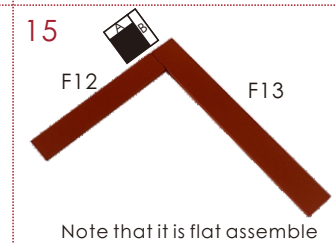
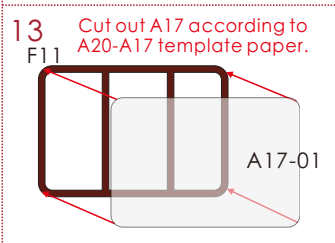
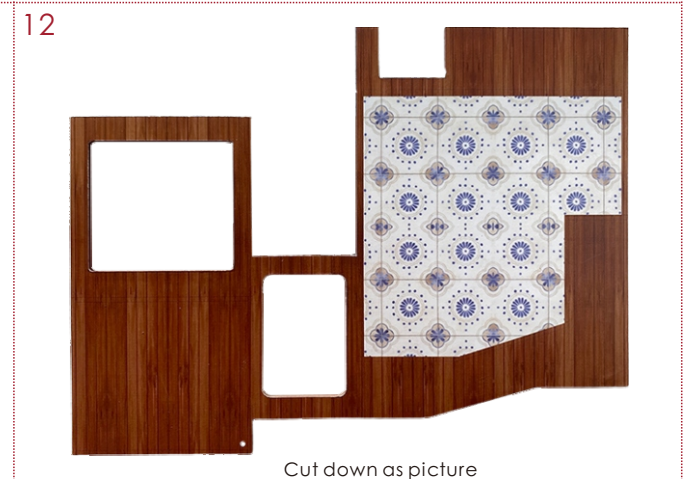
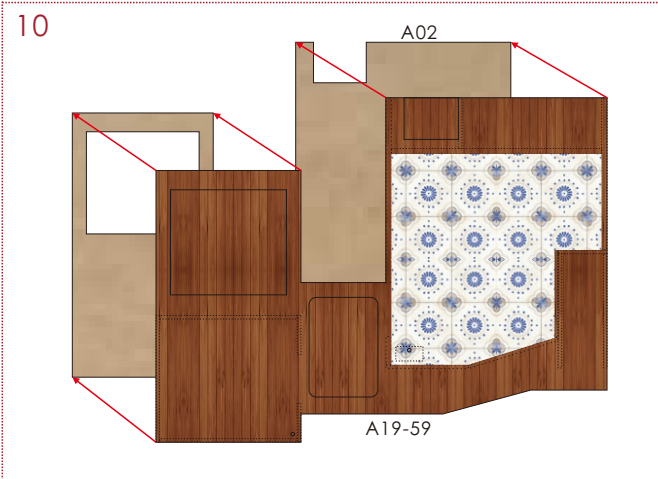
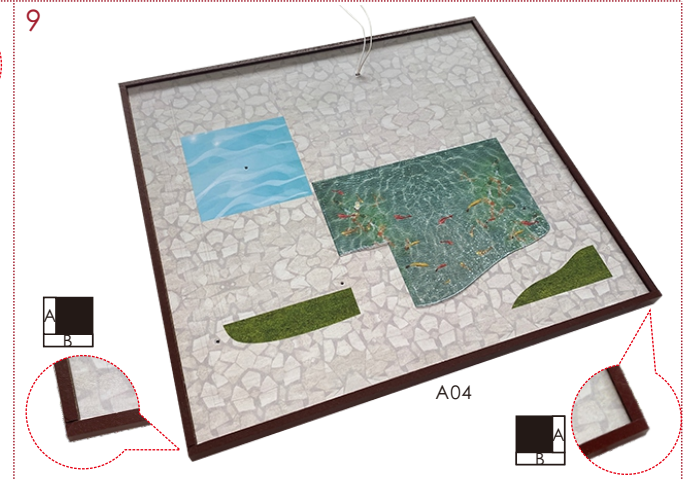
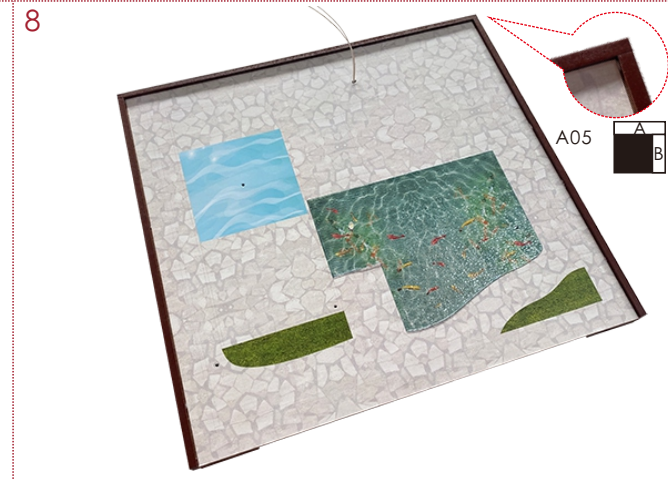
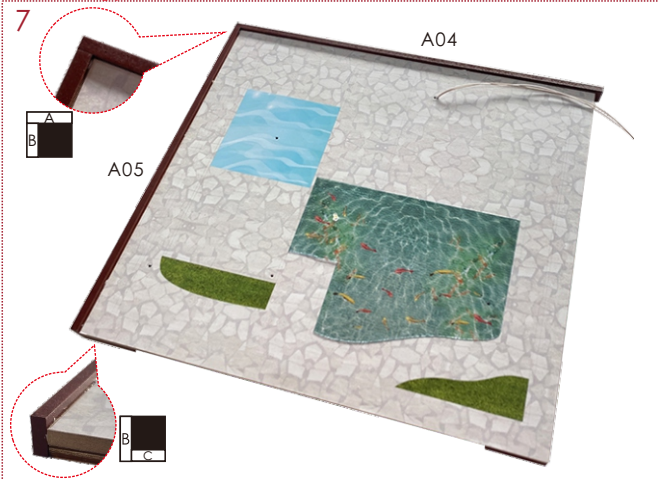

*Tips for cutting and making template paper: Put the whole template on the back of the material, fix it with some small double-sided tape, and then cut out the material to prevent the fabric or template from moving during the cutting process, or cause errors in the cut material. Or lead to insufficient material.

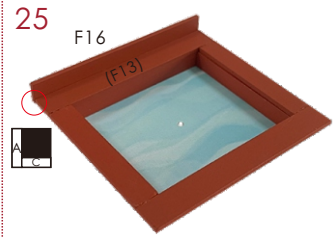

Flip to the back and install the hot spring pool

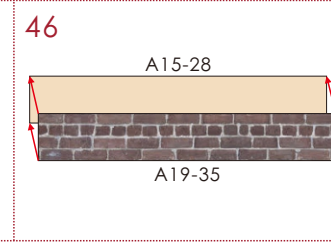
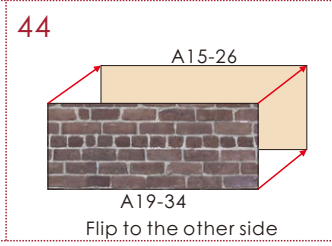
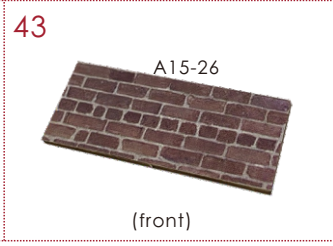
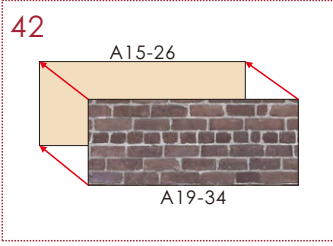
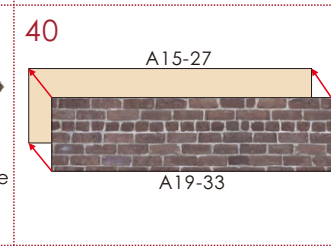
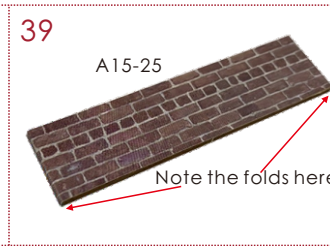
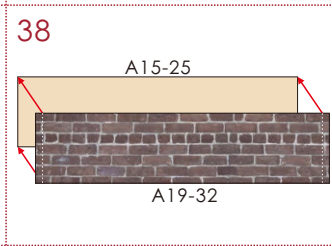
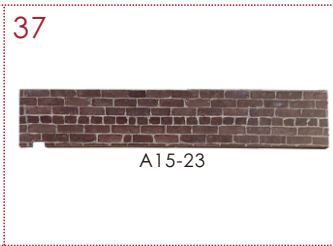
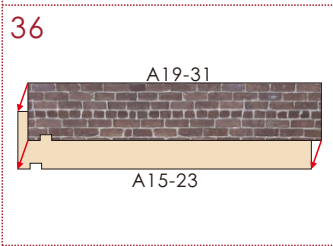
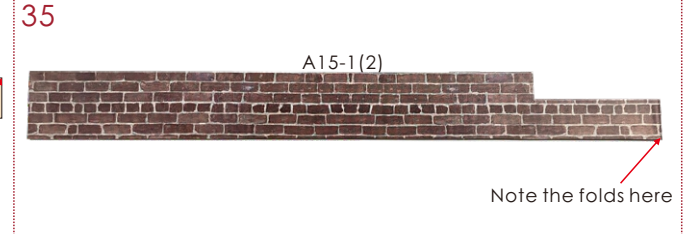
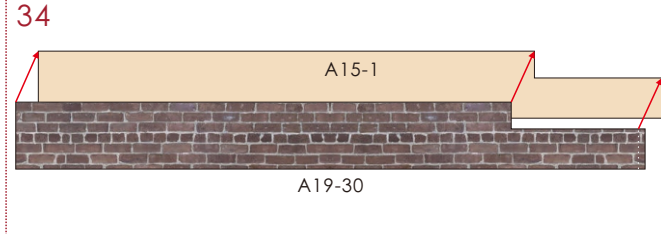
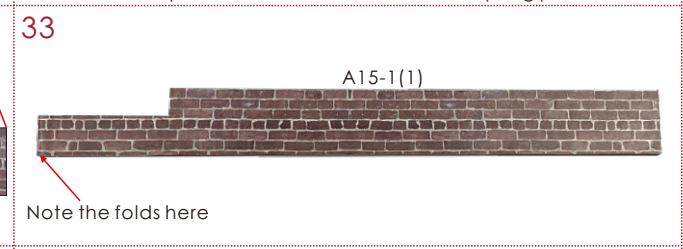
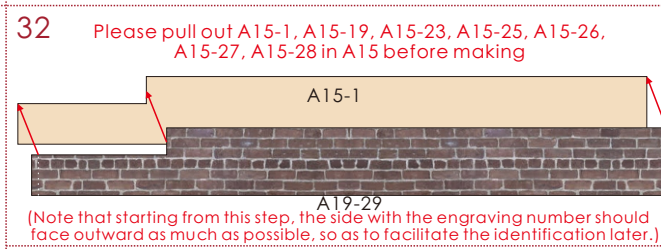

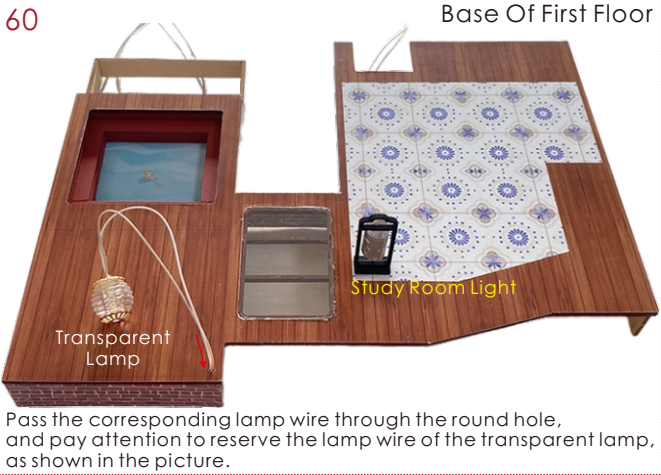
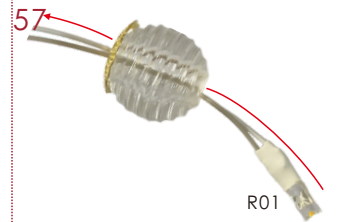
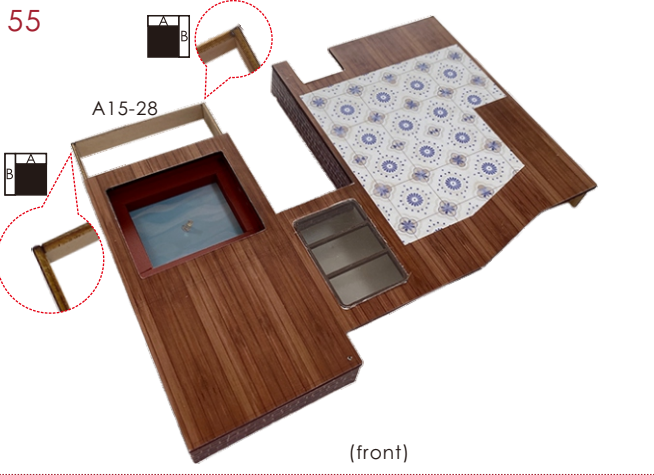
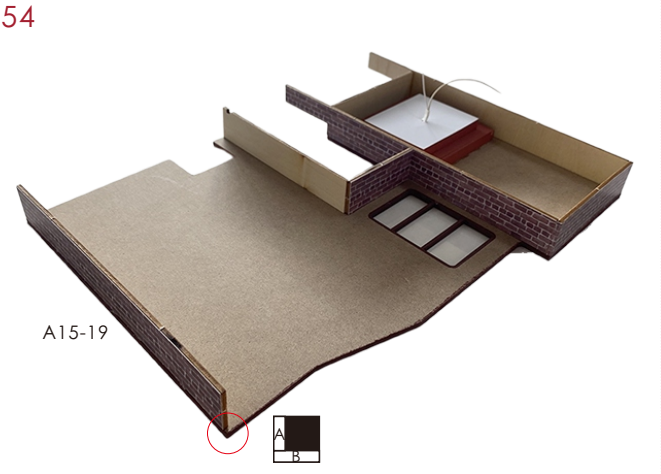
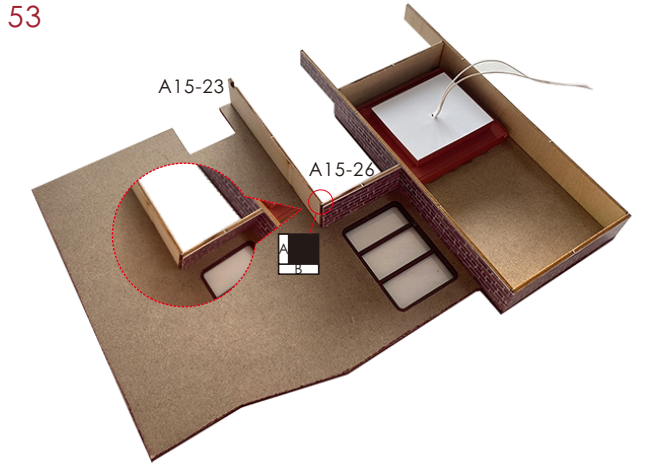
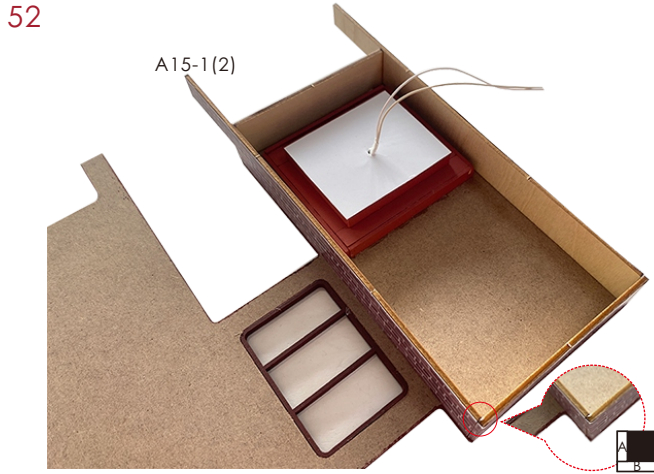
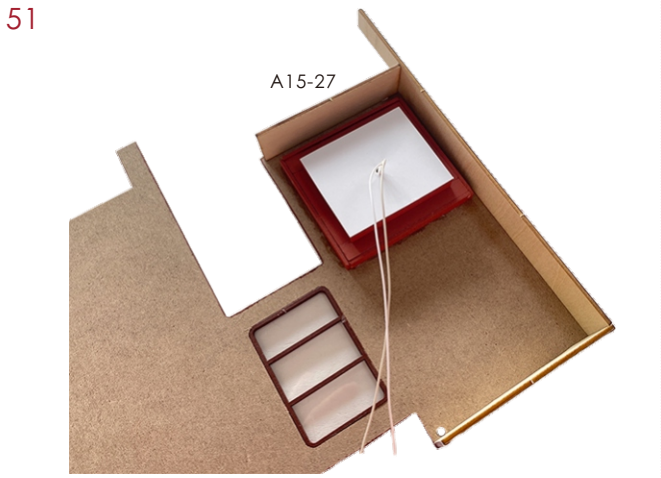
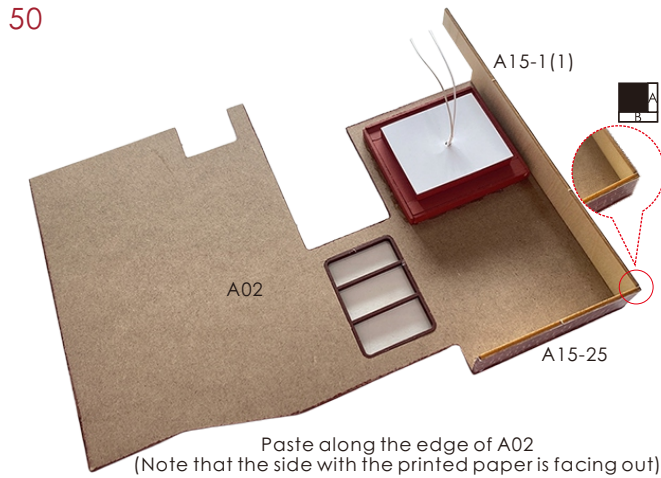
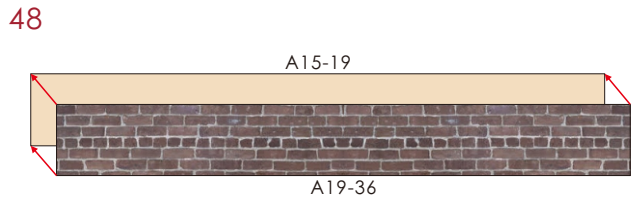



Paste the base of the first floor with reference to the reference line of the floor, pay attention to pass the lamp wire through the corresponding round hole first.



Be careful not to stick the light wire of the transparent light tightly, so that it can be stretched and used later.

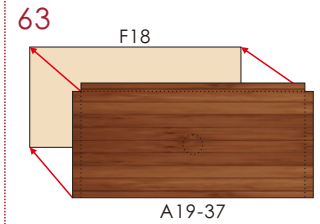

Add R01 to the corresponding sides

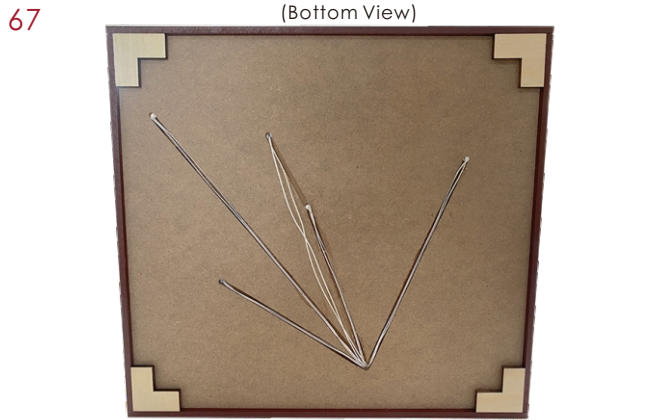

Hide the light wire in the groove (Be careful not to stick the light wire of the transparent light tightly, so that it can be stretched and used later)

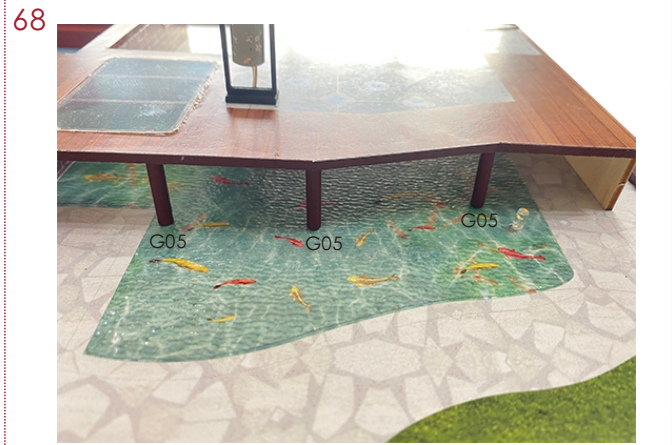

Add G05 with reference to floor reference line



*Tips for cutting and making template paper: Put the whole template on the back of the material, fix it with some small double-sided tape, and then cut out the material to prevent the fabric or template from moving during the cutting process, or cause errors in the cut material. Or lead to insufficient material.

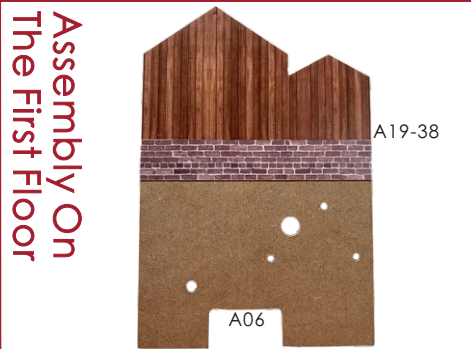

3 Upgraded accessories (Need to purchased separately)

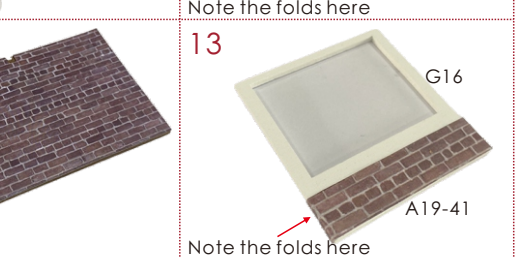
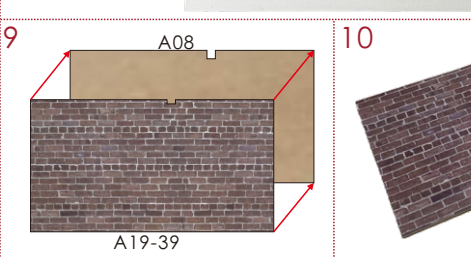
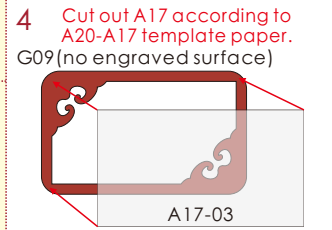
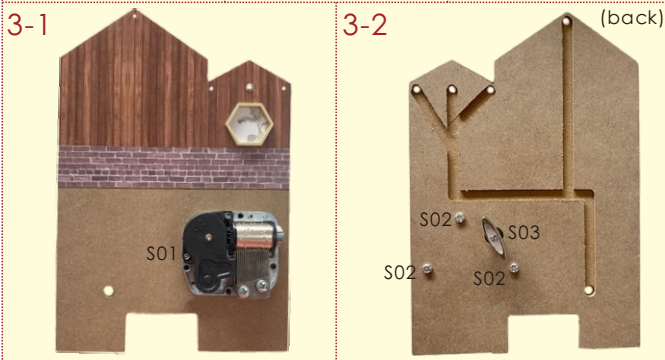
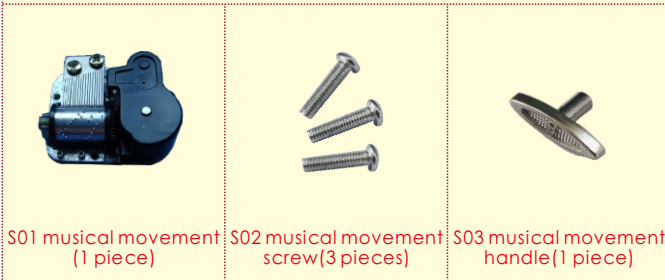

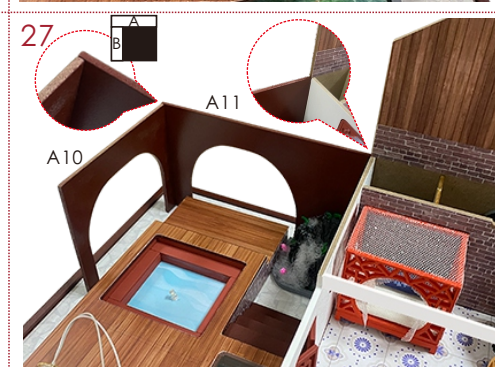
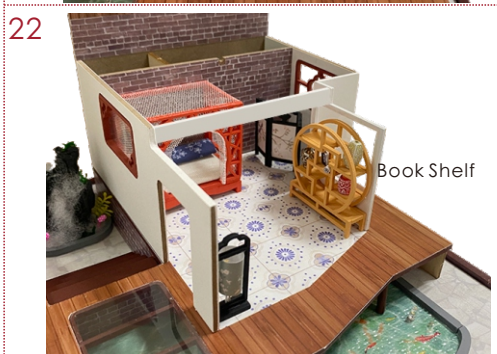
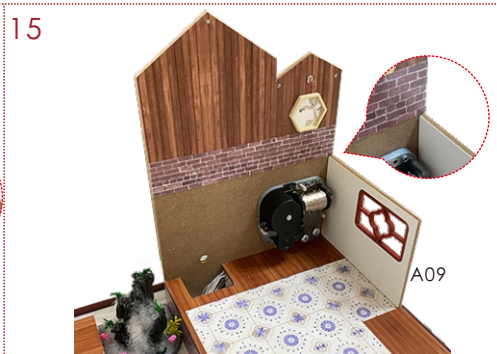

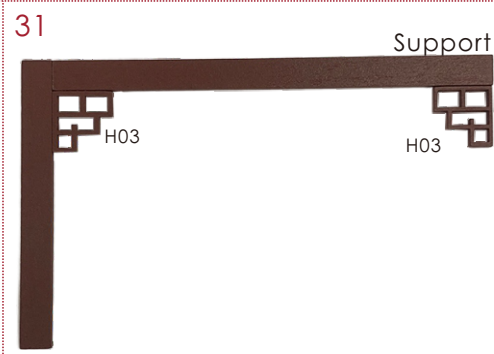
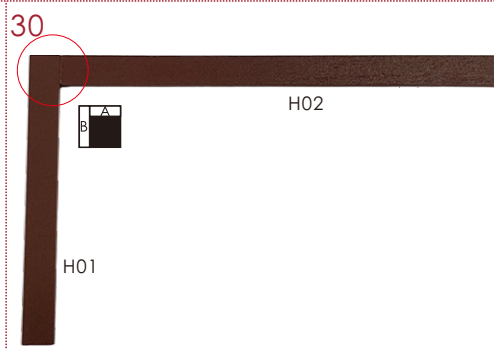

33 Please pull out A15-21 in A15 before making

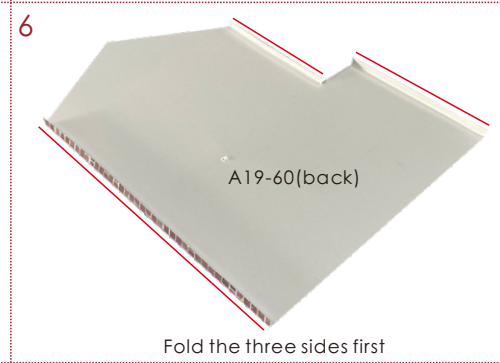
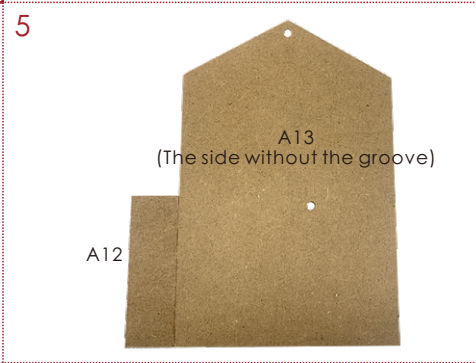
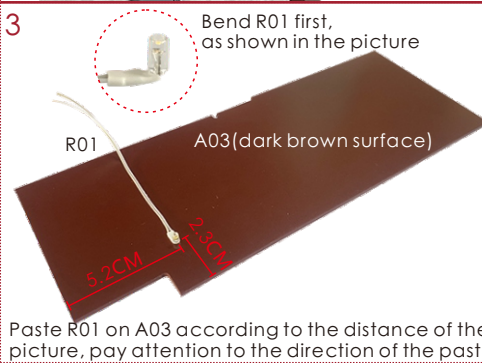
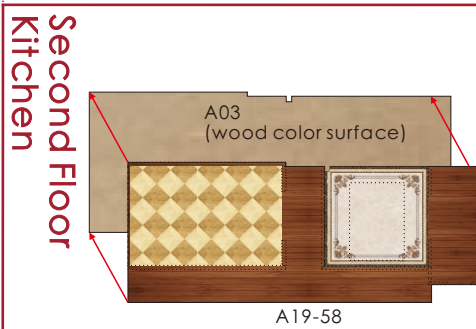
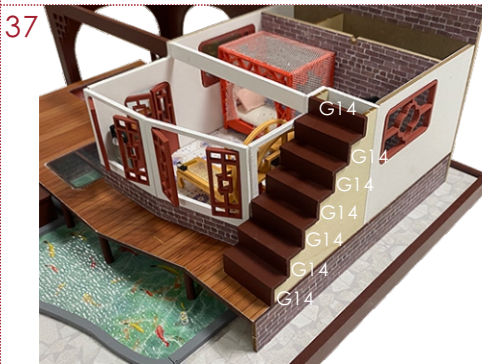
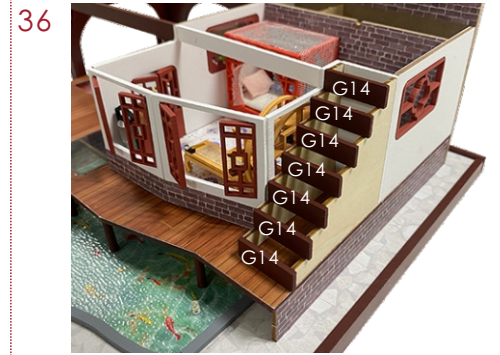
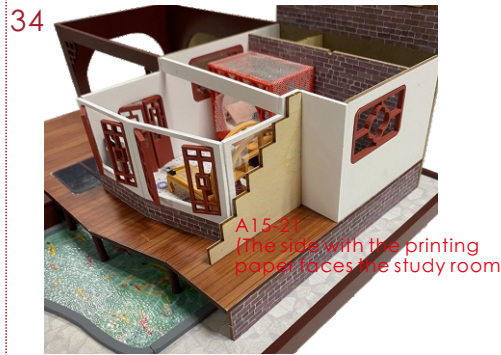
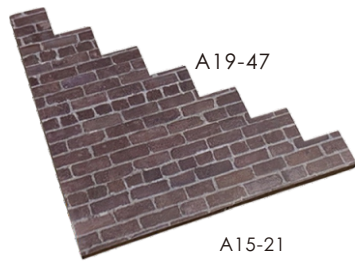

*Tips for cutting and making template paper: Put the whole template on the back of the material, fix it with some small double-sided tape, and then cut out the material to prevent the fabric or template from moving during the cutting process, or cause errors in the cut material. Or lead to insufficient material.

<p>7</p> <p>A19-60</p>	<p>8</p>	<p>9</p> <p>Cut out A17 according to A20-A17 template paper.</p> <p>A17-04</p> <p>H06(no engraved surface)</p>	<p>10</p> <p>(front)</p>	<p>11</p> <p>H05</p>	<p>12</p> <p>A19-49</p> <p>Note the folds here</p>
<p>13</p> <p>A17-05</p> <p>H08(no engraved surface)</p>	<p>14</p> <p>(front)</p>	<p>15</p> <p>H07</p>	<p>16</p> <p>A19-42</p> <p>A19-43</p>	<p>17</p> <p>H10</p>	
<p>18</p> <p>Light wires pass through holes and openings in bulkheads</p> <p>A03</p>	<p>19</p> <p>Pull the light wires all the way to the back.</p>	<p>20</p> <p>H05 PVC side facing inward</p>			
<p>21</p> <p>Dresser</p> <p>Pass the light wire through the round hole</p>	<p>22</p> <p>Pull the light wires all the way to the back</p>	<p>23</p> <p>H09</p> <p>Red Stool</p>	<p>24</p> <p>Stove</p>		

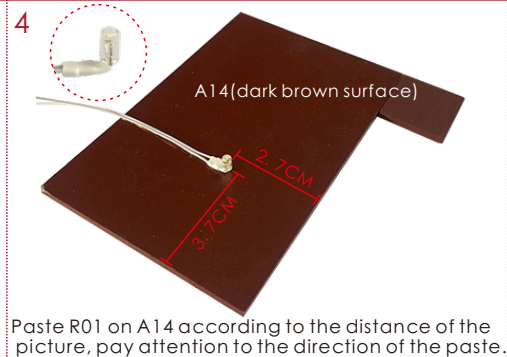
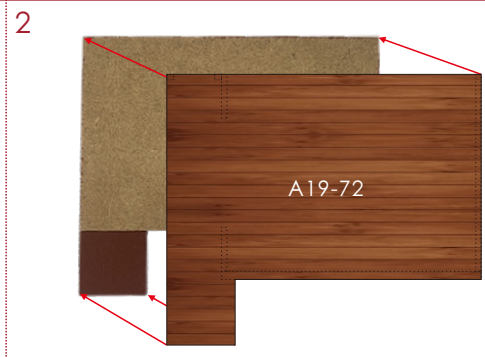
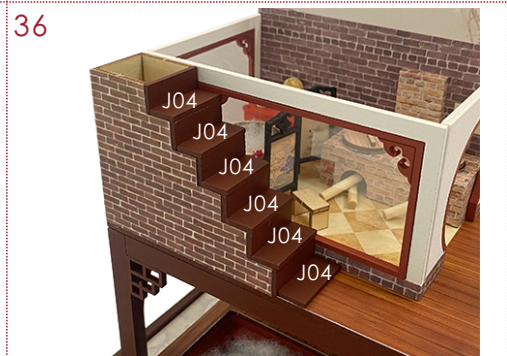
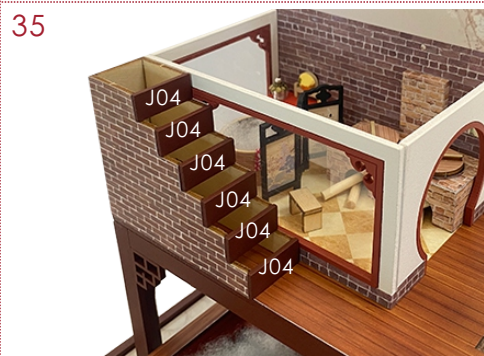
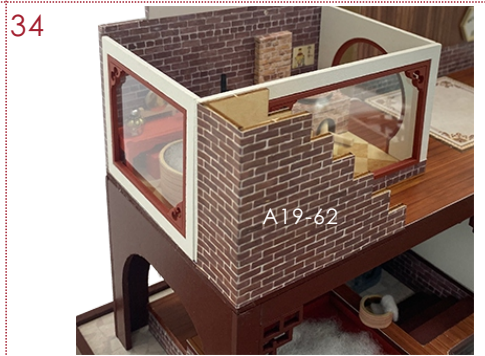
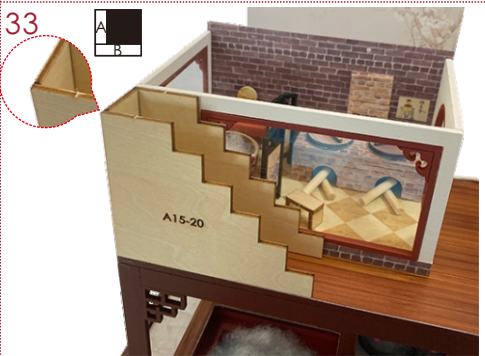

*Tips for cutting and making template paper: Put the whole template on the back of the material, fix it with some small double-sided tape, and then cut out the material to prevent the fabric or template from moving during the cutting process, or cause errors in the cut material. Or lead to insufficient material.

<p>5</p>  <p>Hollow Lampshade</p>	<p>6</p>  <p>J06 A19-50 Note the folds here</p>	<p>7</p> <p>Cut out A17 according to A20-A17 template paper.</p>  <p>J07 A17-12</p>	<p>8</p>  <p>(front)</p>	<p>9</p>  <p>J06</p>	<p>10</p>  <p>J08 A19-51</p>
<p>11</p>  <p>J09 A17-11</p>	<p>12</p>  <p>(front)</p>	<p>13</p>  <p>J08</p>	<p>14</p>  <p>J10 A19-52 A19-52</p>	<p>15</p>  <p>Calligraphy Flip to the other side</p>	<p>16</p>  <p>A19-45 roll up the ends</p>
<p>17</p>  <p>J10 A19-45</p>	<p>18</p>  <p>A19-46 Fold it first</p>	<p>19</p> <p>Please pull out A16-1 in A16 before making</p>  <p>Pedal A16-1</p>	<p>20</p>  <p>Q14 25CM*2 pieces</p>	<p>21</p> 	<p>22</p>  <p>Cushion Make 2 pieces in the same way</p>
<p>23</p>  <p>Pass the light wire through the round hole</p> <p>12</p>	<p>24</p> 	<p>25</p>  <p>J08 (PVC side facing inward)</p>	<p>26</p>  <p>J10</p>		
<p>27</p>  <p>Bedside Table Pedal</p>	<p>28</p>  <p>cushion Low Table cushion</p>	<p>29</p>  <p>Master Bed</p>			

*Tips for cutting and making template paper: Put the whole template on the back of the material, fix it with some small double-sided tape, and then cut out the material to prevent the fabric or template from moving during the cutting process, or cause errors in the cut material. Or lead to insufficient material.

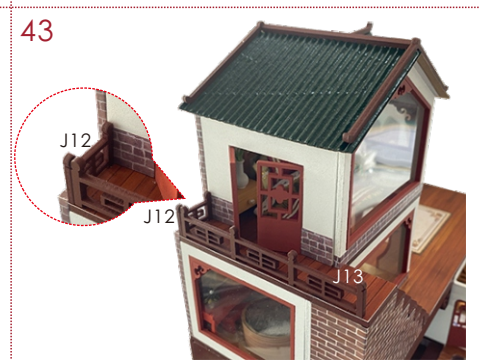
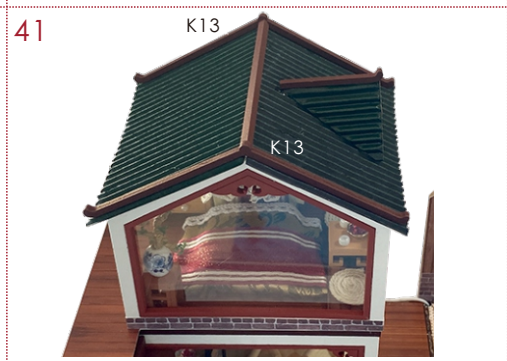
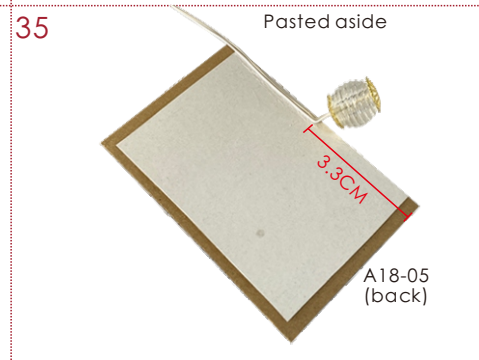
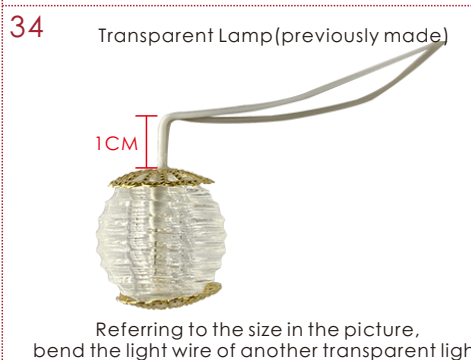
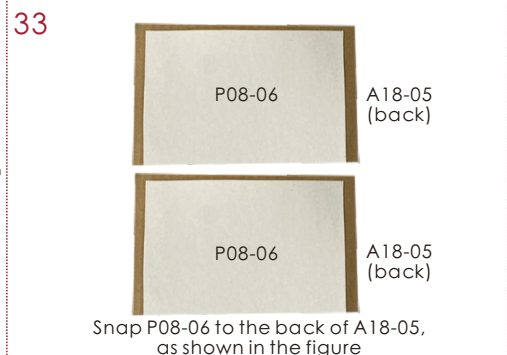
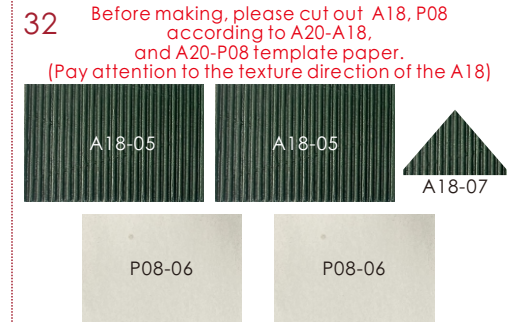

46



Hide the light wires on the back into the grooves and pass them through the round hole on the left

47



Glue the light wires and pull all the light wires out to the opening on the left

48

Please pull out A15-15 in A15 before making



49

Before making, please cut out A18, P08 according to A20-A18, and A20-P08 template paper. (Pay attention to the texture direction of the A18)

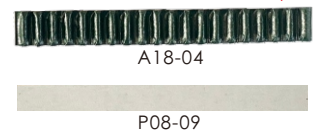

51



50



Glue P08-09 on the back of A18-04, as shown in the picture

Assembly On The Second Floor

Cut out A17 according to A20-A17 template paper.



2



(front)

3

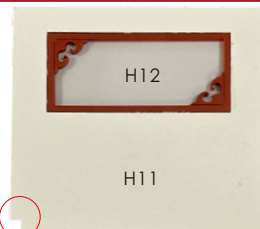

4

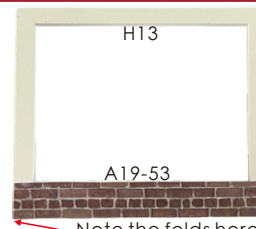

9



10

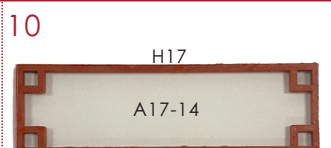

11

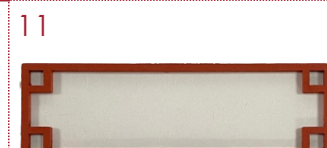

(front)

12

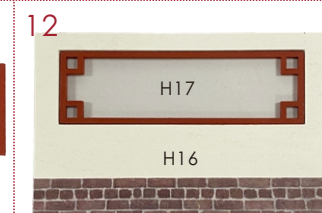

13

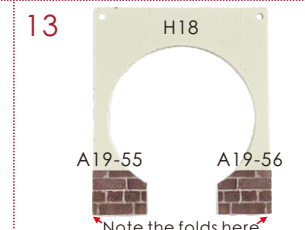

14



15



16



17



18



19



20



lantern
Make 2 pieces in the same way

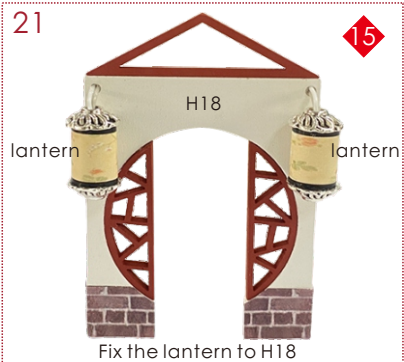

15

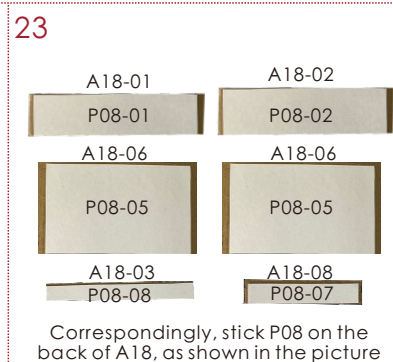
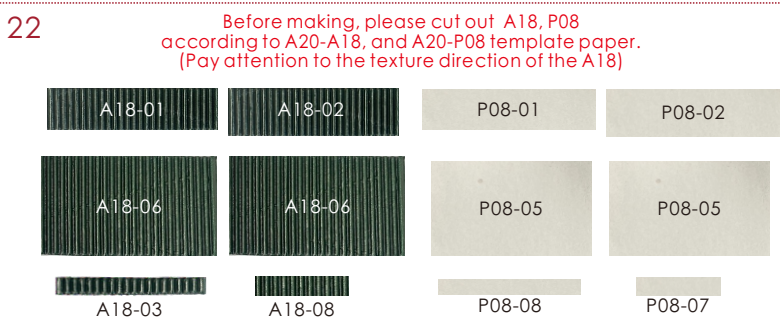

16



17

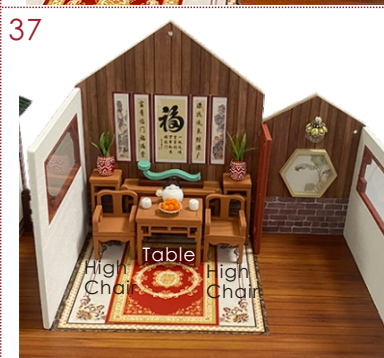

40

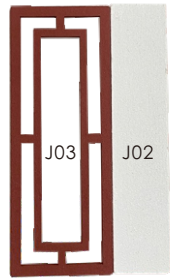

18

41



42



43

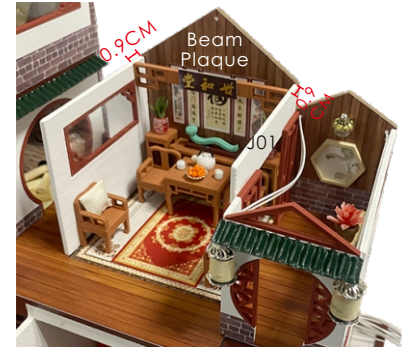

44



45



46 Pass the light wire through the round hole

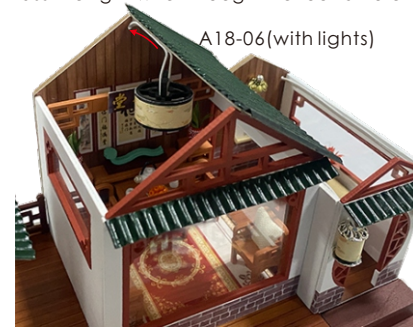

47



48



49

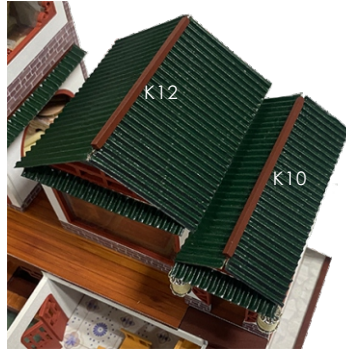

50

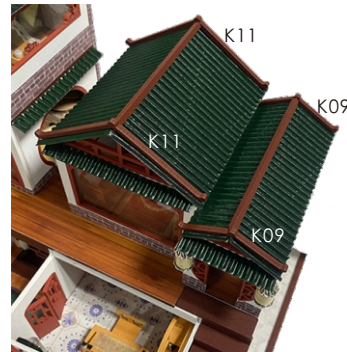

51



Roof Of Study Room & Assembly The Pavillon



2

Please pull out A15-17, A15-18 in A15 before making



3







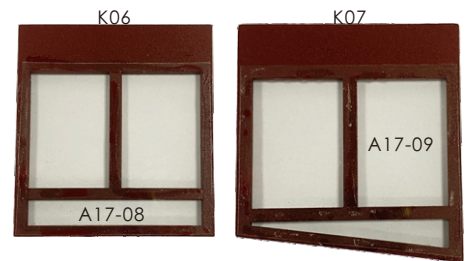











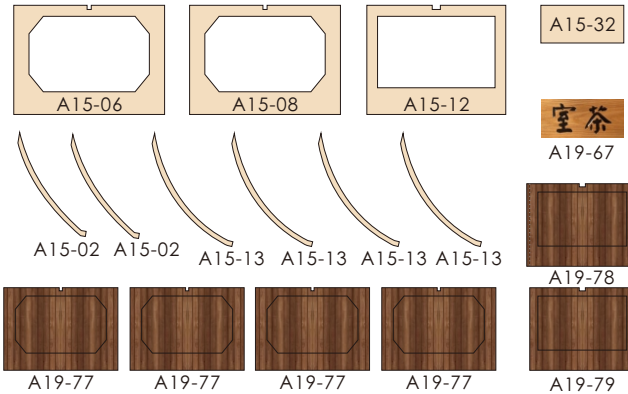
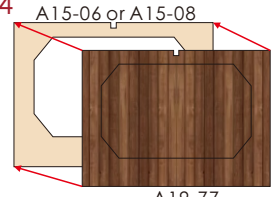

4

Cut out A17 according to A20-A17 template paper.

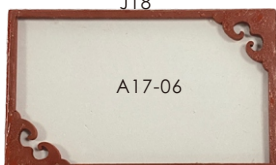

(Pay attention to the direction of pasting.)

<p>5</p>  <p>(front)</p>	<p>6</p> 	<p>7</p> 	<p>8</p>  <p>Q11</p> <p>Add appropriate amount of Q17</p>		
<p>9</p>  <p>Q11</p> <p>Trim some branches of another Q11, as shown in the picture</p>	<p>10</p>  <p>Q02</p> <p>Q02</p> <p>Trim two Q02, as shown in the picture</p>	<p>11</p>  <p>Q11</p> <p>Q02</p> <p>Add Q02 and Q11 on the right as shown</p>	<p>12</p>  <p>Q17</p>		
<p>13 Before making, please cut out A15-2, A15-6, A15-8, A15-12, A15-13, A15-32 in A15 (Please refer to page 1 for production techniques)</p>  <p>A15-06 A15-08 A15-12</p> <p>A15-02 A15-02 A15-13 A15-13 A15-13 A15-13</p> <p>A19-67</p> <p>A19-77 A19-77 A19-77 A19-77 A19-79</p>	<p>14 A15-06 or A15-08</p>  <p>A19-77</p> <p>18</p>  <p>Make 2 pieces in the same way</p>	<p>15</p>  <p>16</p>  <p>Cut down as picture</p> <p>19</p>  <p>A15-12</p> <p>A19-78</p>	<p>17</p>  <p>A19-77</p> <p>Glue the back</p> <p>20</p>  <p>Note the folds here</p>	<p>21</p> 	
<p>22</p>  <p>A19-79</p> <p>Glue the back</p>	<p>23</p> <p>Cut out A17 according to A20-A17 template paper.</p> <p>J18</p>  <p>A17-06</p>	<p>24</p>  <p>(front)</p>	<p>25</p>  <p>A15-12</p> <p>J18</p> <p>20</p>	<p>26</p>  <p>J19</p> <p>A17-07</p>	<p>27</p>  <p>(front)</p>



Make 2 pieces in the same way

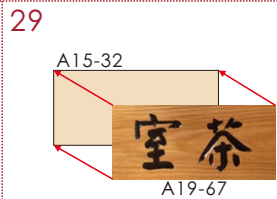

Put 2 pieces of A15-13 side by side
In the same way, make 2 group



Note the folds here

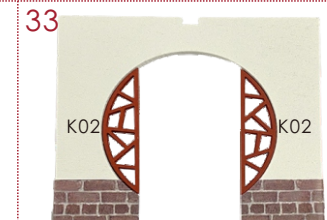

PVC side facing inward



Please be careful not to stretch the light wire of the transparent lamp excessively. Avoid short ends



Align the A15-13 with the buckle, as shown in the picture

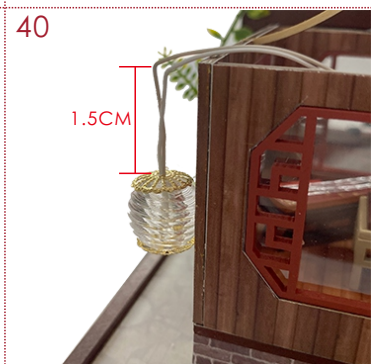

Refer to the size in the picture, bend the light wire first



Paste the light wire along the skeleton, as shown in the picture



Glue the light wire along the wall

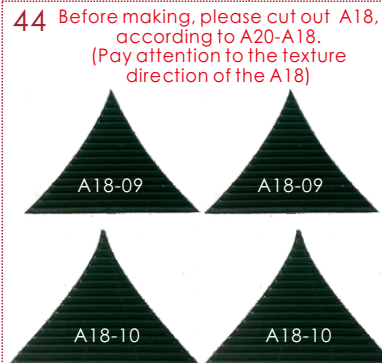

Paste A18-09 symmetrically along the skeleton

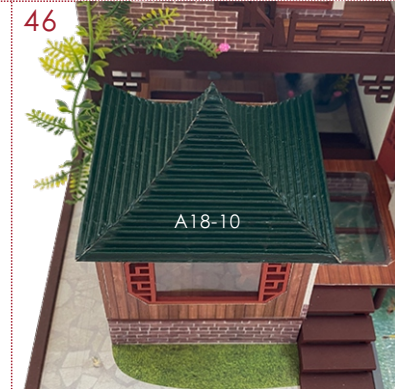



Courtyard Layout

Before making, please cut out all the wood grains in L02



Pay attention to the splicing direction



Add appropriate amount of Q17 as photo



Add appropriate amount of Q15 as photo

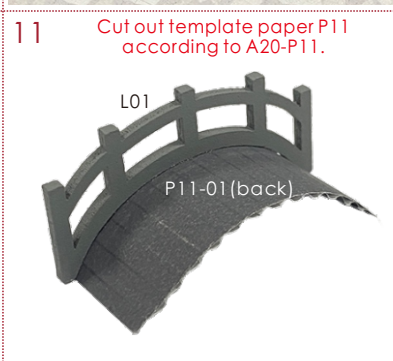
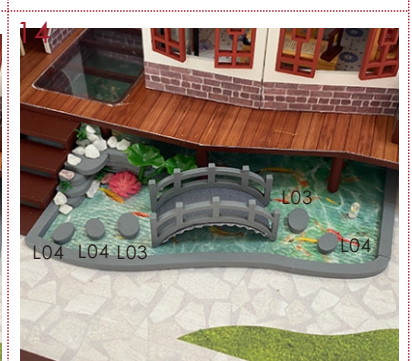
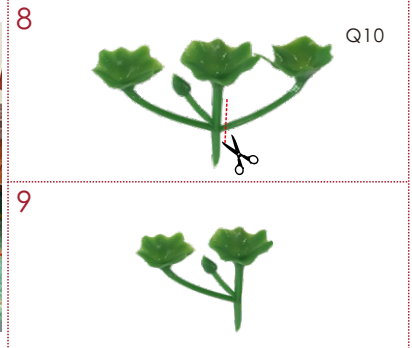









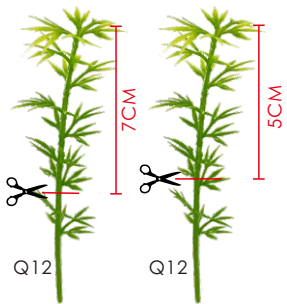

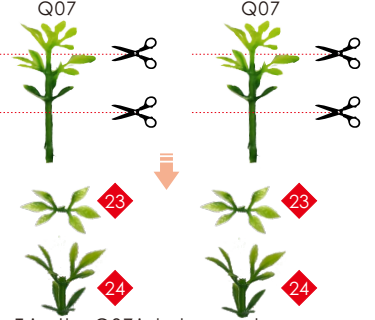
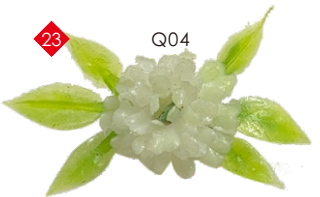

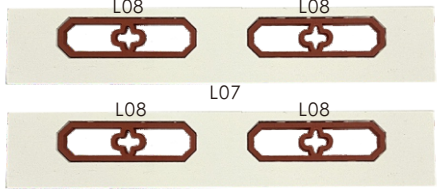
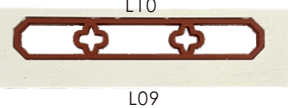

Cut out the leaves of Q11, add them as shown in the picture



Cut out the A19-71 and add it in place

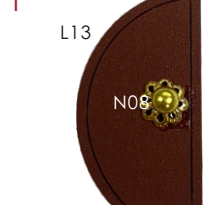

<p>19</p>  <p>A19-70</p>	<p>20</p>  <p>M17 N05</p> <p>Lampshade</p>	<p>21</p>  <p>7CM 5CM</p> <p>Q12 Q12</p> <p>Follow the prompts to trim the Q12 to the corresponding height</p>	<p>22</p>  <p>Q12 Q12</p>	<p>23</p>  <p>Q07 Q07</p> <p>23 23 24 24</p> <p>Trim the Q07 into two parts In the same way, make 2 pieces</p>
<p>24</p>  <p>23 Q04</p> <p>Glue the trimmed top with Q04</p>	<p>25</p>  <p>Lampshade Q17</p> <p>Enclose the green area with Q17</p>	<p>26</p>  <p>Q12 Q12</p>	<p>27</p>  <p>Q05 Q09 Q09 Q04</p> <p>White Flowers</p> <p>Put the plants as shown</p>	
<p style="writing-mode: vertical-rl; transform: rotate(180deg);">Fence & Doorway</p> <p>1</p>  <p>L06 L06 L05</p>	<p>2</p>  <p>L08 L08 L08 L08 L07</p>	<p>3</p>  <p>L10 L09</p>	<p>4</p>  <p>N10 M07</p>	
<p>5</p>  <p>N10</p> <p>Make 2 pieces in the same way</p>	<p>6</p> <p>Before making, please cut out A18, according to A20-A18. (Pay attention to the texture direction of the A18)</p>  <p>A18-11 L11</p> <p>Note that the A18-11 is projected forward by about 0.7CM</p>	<p>7</p>  <p>L12</p>	<p>8</p>  <p>L12</p>	<p>13</p>  <p>L05</p>
<p>9</p>  <p>Red Beads Red Beads</p>	<p>10</p>  <p>L13 N09</p>	<p>11</p>  <p>L13 N09</p>	<p>12</p>  <p>L14</p> <p>In the same way, make the other side</p>	

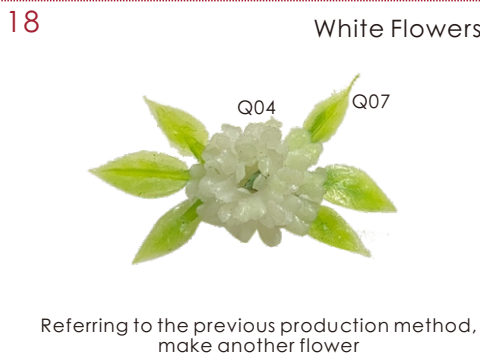
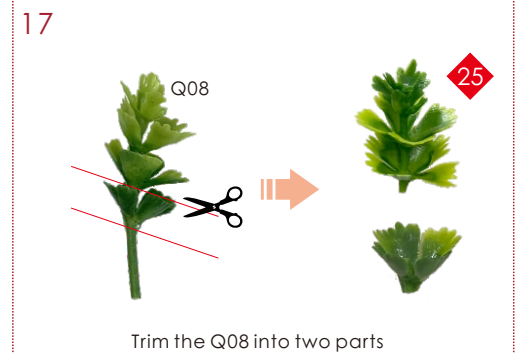

How to assemble the battery holder



Hide the light wires on the back into the grooves

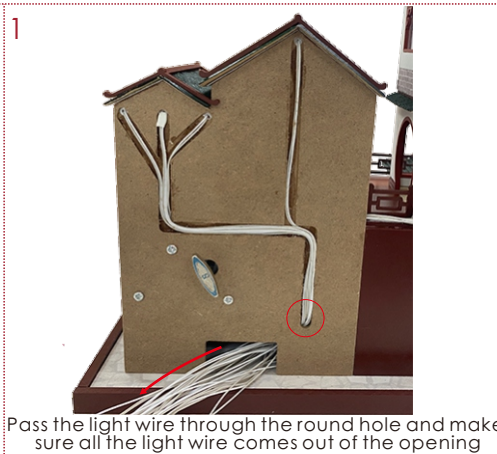

1 Pass the light wire through the round hole and make sure all the light wire comes out of the opening



2 Before pasting A19-73, twist out S03



Note the folds here

A19-76

5 **Statement:**
the lamp wires cannot be inserted into the output socket.

- - Can use 2*AAA batteries
- - Please notice the place of anode and cathode when pit in the batteries
- - Rechargeable batteries are not blunt electricity
- - Rechargeable batteries can only be charged under adult supervision
- - Rechargeable batteries should be removed from the toy before charging
- - Different types of batteries cannot mix; Do not mix new batteries in use with semi-used batteries.
- - Run out of battery should be removed from the toy
- - The power shall not be short circuit

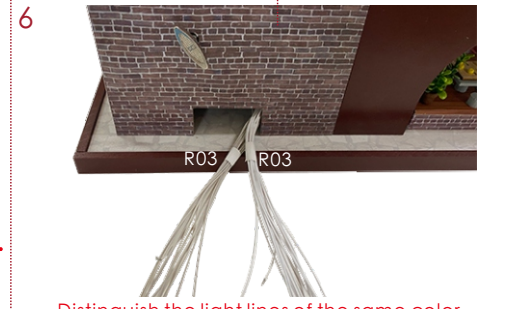

Distinguish the light lines of the same color.

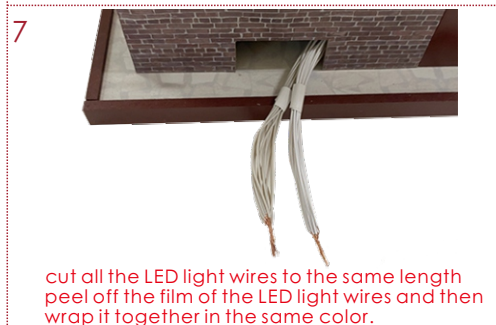

7 cut all the LED light wires to the same length peel off the film of the LED light wires and then wrap it together in the same color.

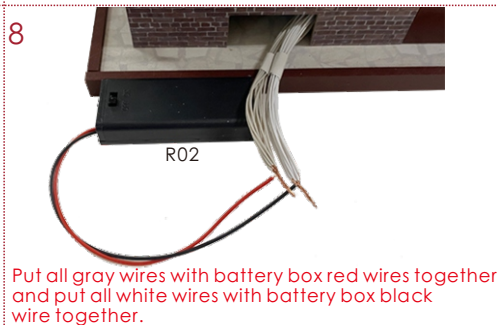

8 Put all gray wires with battery box red wires together, and put all white wires with battery box black wire together.

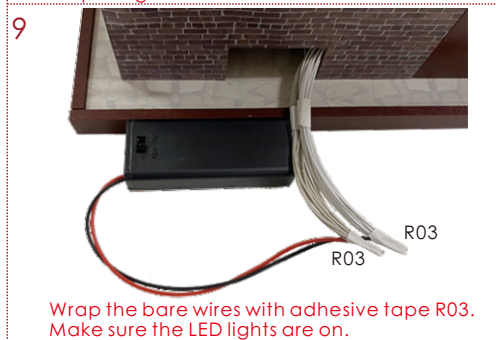

9 Wrap the bare wires with adhesive tape R03. Make sure the LED lights are on.



Installation of dust cover

Dust cover
(Upgrade version accessories need to be purchased separately)



ratio:1:10
Z01 plexiglass(transparent)
29*25.5*0.18(2 pieces)



ratio:1:10
Z02 plexiglass(transparent)
26.64*25.5*0.18(2 pieces)

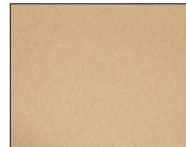

ratio:1:10
Z03 plexiglass(transparent)
29*27*0.18(1 pieces)

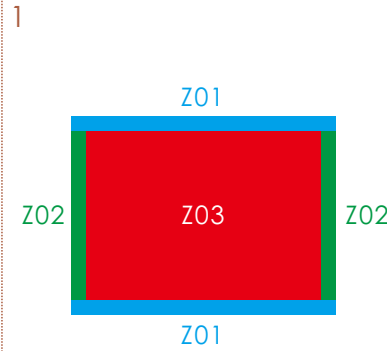

stick Z01 and Z02 on Z03

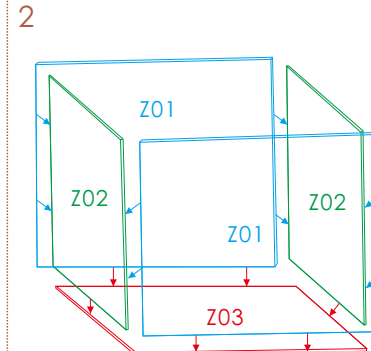

stick five pieces of plexiglass dust cover as shown



Ripped one side of kraft paper, leaving one side of kraft paper

Take out the plexiglass and tear off the kraft paper with text on each piece of plexiglass

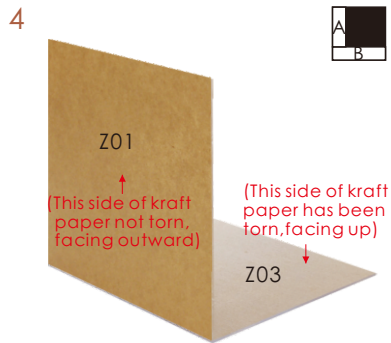

The kraft paper that has been ripped off faces inwards, and the kraft paper that has not been ripped out faces outwards.

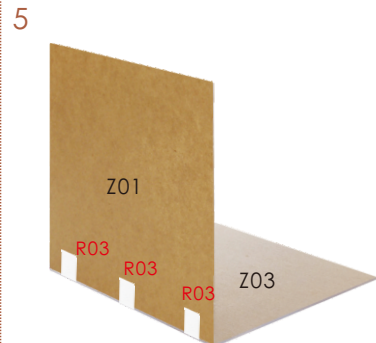

Use R03 to fix the junction of two pieces of plexiglass, (use transparent tape to replace R03)

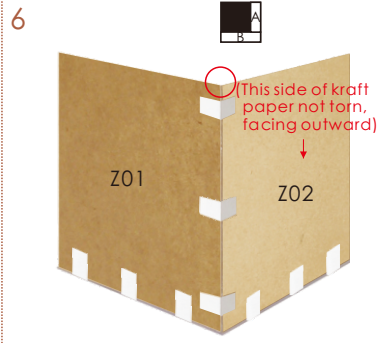

The junction of every two pieces of plexiglass needs to be fixed with R03 (to prevent the plexiglass falling off)

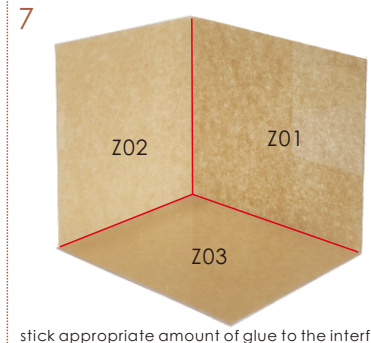

stick appropriate amount of glue to the interface of the two pieces of glass and scrape it slightly to make the glue penetrate into the junction of the two pieces of glass (the red line is the plexiglass interface)

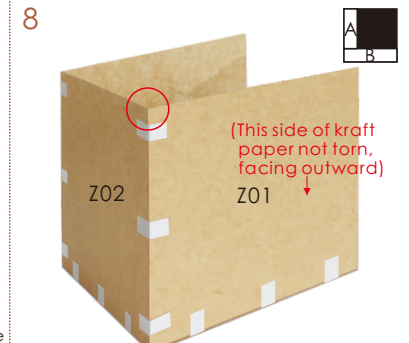

The junction of two pieces of plexiglass needs to be fixed with R03 (to prevent the plexiglass falling off)

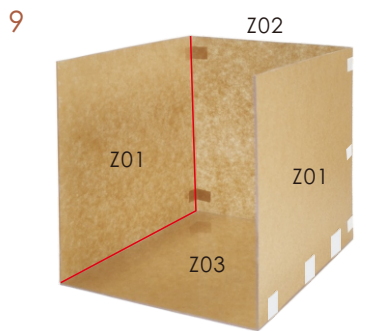

stick appropriate amount of glue to the interface of the two pieces of glass and scrape it slightly to make the glue penetrate into the junction of the two pieces of glass (the red line is the plexiglass interface)

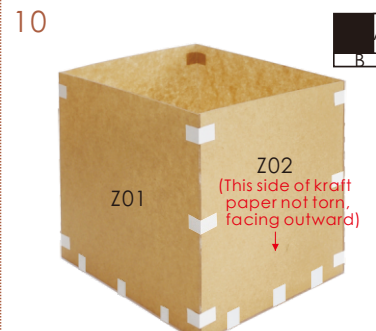

The junction of two pieces of plexiglass needs to be fixed with R03 (to prevent the plexiglass falling off)

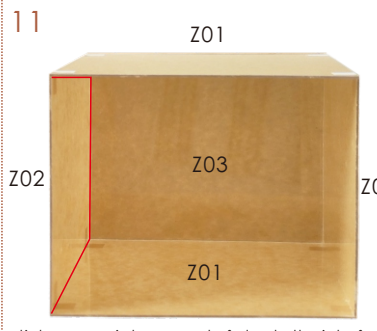

stick appropriate amount of glue to the interface of the two pieces of glass and scrape it slightly to make the glue penetrate into the junction of the two pieces of glass (the red line is the plexiglass interface)

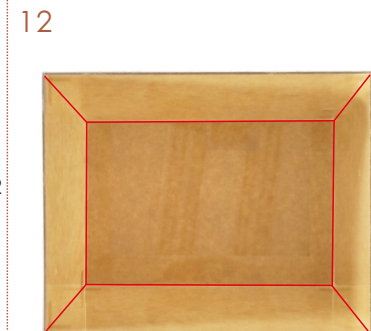

The dust cover need to be glued 8 interfaces

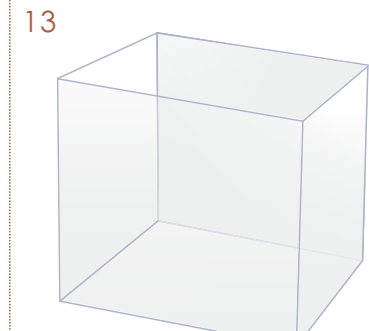

Leave it for 1 hour. After the glue dries out, tear off a layer of kraft paper outside the plexiglass

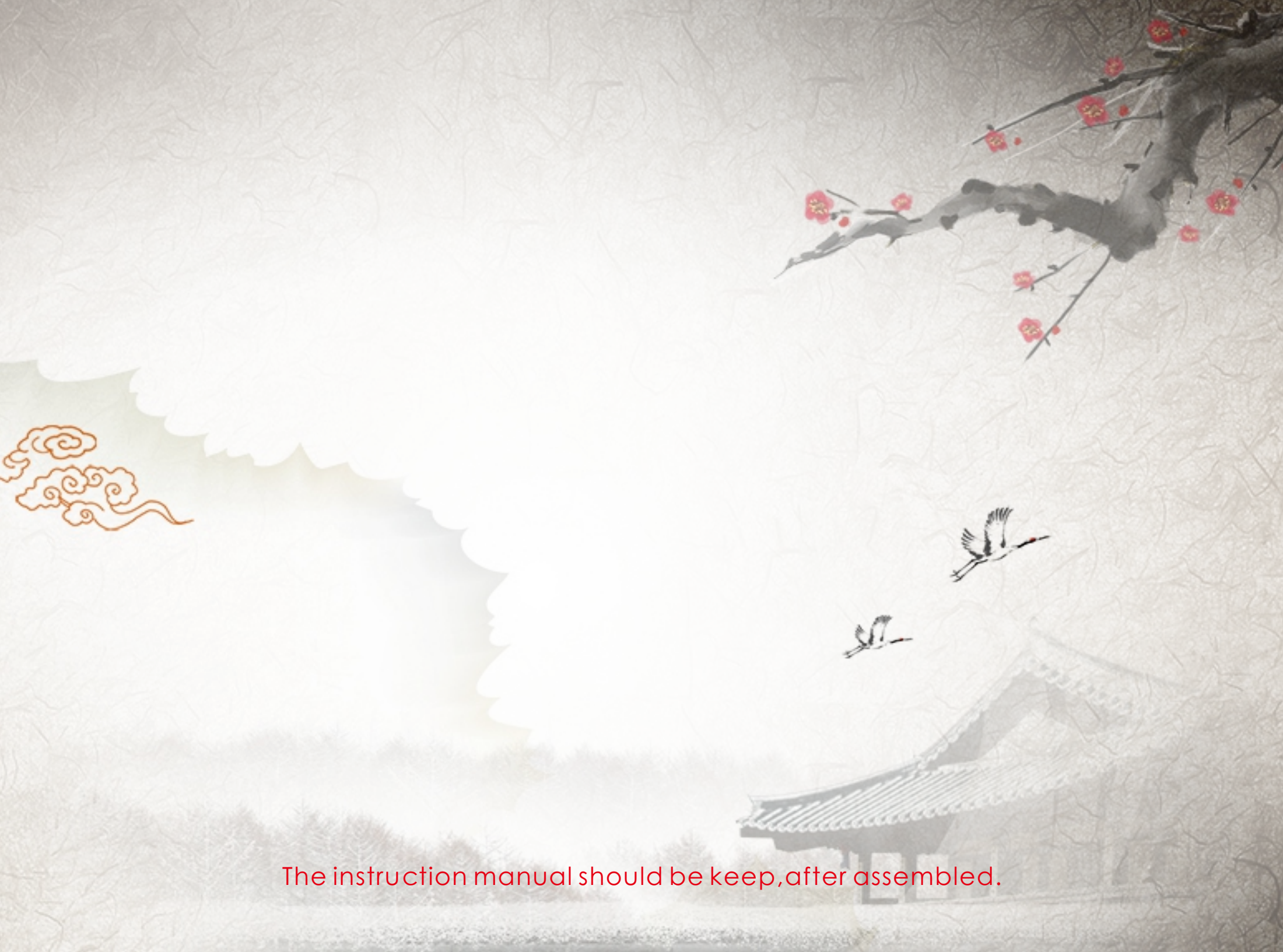

The instruction manual should be keep, after assembled.